

TECHNICAL DATA SHEET

Laparoscopy Drape

(EU) 2017/745 Annex XI-Part A Production Quality Assurance.

Laparoscopy Drape Features

▶ Product Description	▶ Protective equipment used by doctors or nurses for surgical operations to prevent the possible risk of infection.
▶ Product Class	▶ (EU) 2017/745 Medical Device Regulation – Class Business Rule I
▶ Manufacturer's Location	▶ Tio Medikal 2/20 st.No.53 (Begos 3. North Entrance, 35400 Buca OSB/Buca/İzmir)
▶ Purpose of usage	▶ This product is produced for laparoscopic operations. On the drape there is a window covered with a polyurethane incision film. Also, there are PE liquid collection bags around the window.

Quality

- Manufactured under ISO 13485:2016 and 13795-1 quality management standards.
- It has CE certificate.

Bio-Compatibility

- Does not contain latex.
- Sterilized with ethylene oxide.

Relevant Standard

- ISO 13485:2016 Medical Medical Devices Quality Management System
- 9001:2015 Quality Management System
- TS EN 13795 Surgical Garments and Drapes
- TS EN ISO 11607-1:2017 Packaging for finally sterilized medical devices - Part 1: Rules for materials, sterile barrier systems and packaging systems / Products are made in accordance with the relevant standard.

- TS EN ISO 11607-2:2017 Packaging of medical devices-Finally sterilised-Part 2: Validation requirements for forming, sealing and joining processes/ Products are made in accordance with the relevant standard.

Shelf Life

- 3 years

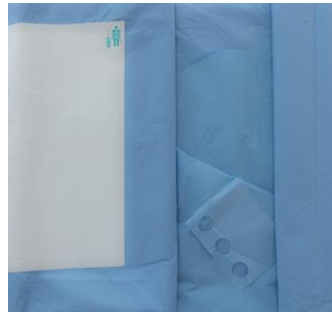

Figure 1. Laparoscopy Drape Display

1. Laparoscopy Drape Sizes

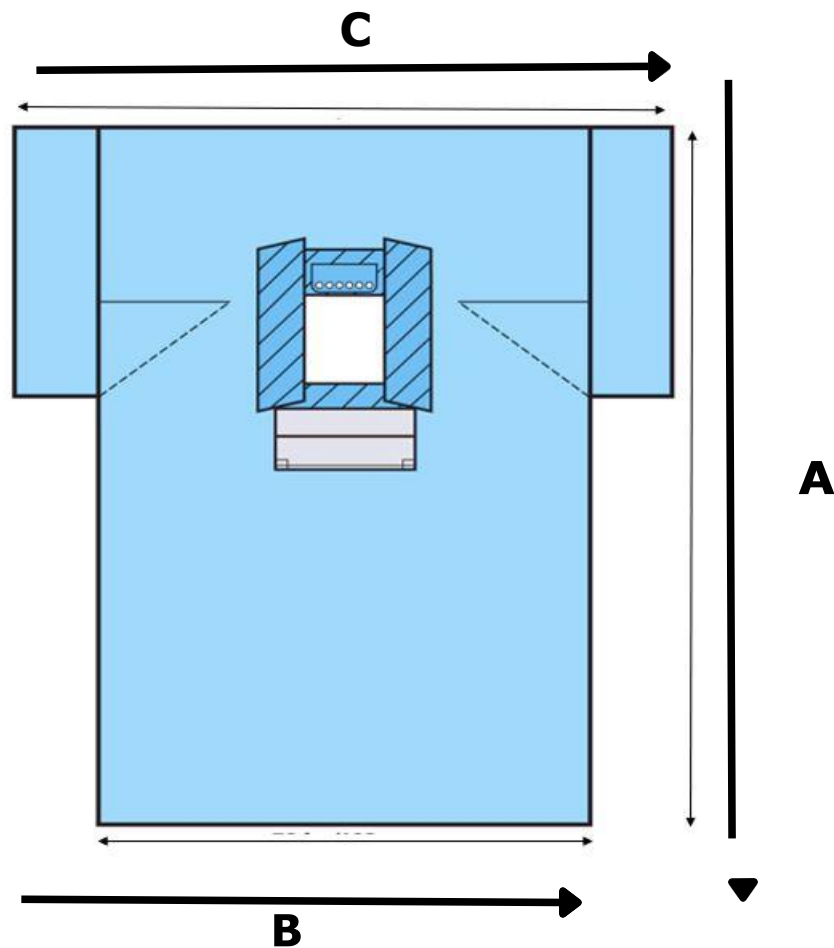

Figure 1 Laparoscopy Drape Technical Demonstration

Available Materials: 02 Dublex(PE /Viscose or PE/Spunbond PP) , 54-56 gr/m2 double sided adhesive tape

REF . CODES	DIMENSIONS (CM)			PIECES IN BOX	
	A	B	C	40x60x40	50x80x50
511.0X.000.01	300	200	250	25	15

Tolerances: +-3% (ALL SIZES ARE PRODUCED & CUSTOMISATION)

2. Laparoscopy Pack Content

Laparoscopy Pack	Size	QTY
Laparoscopy Drape	250*300 cm	1x
Back table cover	150*200cm	1x
Mayo stand cover	75*145cm	1x
Reinforced surgical gown	L	3x
Medical towel	40*40cm	3x
Op tape	10*30cm	1x
non-woven wrap	100*100cm	1x

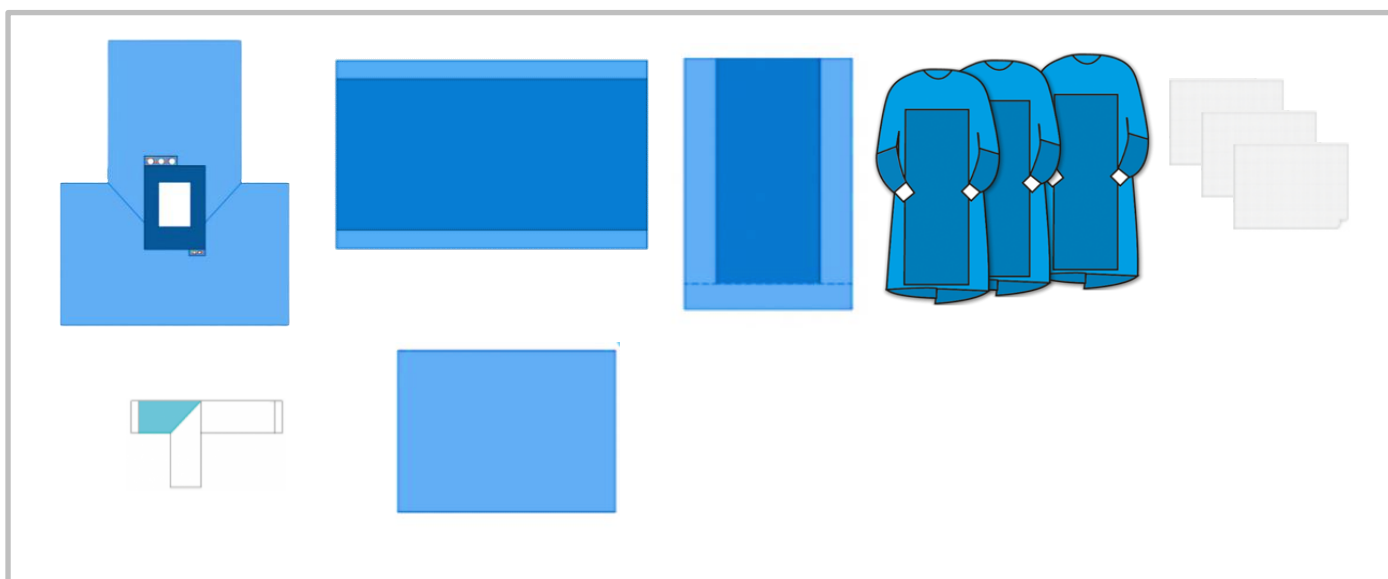

EN 13795 requirements					
Characteristic	Test Method	High performance		Results	Main fabric
		Critical product area	Less critical product area		
Resistance to microbial penetration - Dry (CFU)	EN ISO 22612	Not required	<300	Conformed	- SS Hydrophobic Spunbond - SS Hydrophylic Spunbond - Surgigal drape and gowns-Blue/white non woven - Surgigal drape and gowns-Blue laminated non woven
Resistance to microbial penetration - Wet (I B)	EN ISO 22610	6,0	Not required	Conformed	- SS Hydrophobic Spunbond - SS Hydrophylic Spunbond - Surgigal drape and gowns-Blue/white non woven - Surgigal drape and gowns-Blue laminated non woven
Cleanliness - Microbial (CFU/100cm ²)	EN ISO 11737-1	<300	<300	Conformed	- SS Hydrophobic Spunbond - SS Hydrophylic Spunbond - Surgigal drape and gowns-Blue/white non woven - Surgigal drape and gowns-Blue laminated non woven
Cleanliness - Particulate matter (IPM)	EN ISO 9073-10	<3,5	<3,5	Conformed	- SS Hydrophobic Spunbond - SS Hydrophylic Spunbond - Surgigal drape and gowns-Blue/white non woven - Surgigal drape and gowns-Blue laminated non woven
Linting (Log ₁₀ (lint count))	EN ISO 9073-10	<4,0	<4,0	Conformed	- SS Hydrophobic Spunbond - SS Hydrophylic Spunbond - Surgigal drape and gowns-Blue/white non woven - Surgigal drape and gowns-Blue laminated non woven
Resistance to liquid penetration	EN 13795	≥ 100	≥ 10	Conformed	- SS Hydrophobic Spunbond - SS Hydrophylic Spunbond - Surgigal drape and gowns-Blue/white non woven - Surgigal drape and gowns-Blue laminated non woven
Bursting strength - dry	EN 13795	≥ 40	≥ 40	Conformed	- SS Hydrophobic Spunbond - SS Hydrophylic Spunbond - Surgigal drape and gowns-Blue/white non woven - Surgigal drape and gowns-Blue laminated non woven
Bursting strength - wet	EN 13795	Not required	≥ 40	Conformed	- SS Hydrophobic Spunbond - SS Hydrophylic Spunbond - Surgigal drape and gowns-Blue/white non woven - Surgigal drape and gowns-Blue laminated non woven
Tensile strength - dry	EN 13795	≥ 20	≥ 20	Conformed	- SS Hydrophobic Spunbond - SS Hydrophylic Spunbond - Surgigal drape and gowns-Blue/white non woven - Surgigal drape and gowns-Blue laminated non woven
Tensile strength - wet	EN 13795	Not required	≥ 20	Conformed	- SS Hydrophobic Spunbond - SS Hydrophylic Spunbond - Surgigal drape and gowns-Blue/white non woven - Surgigal drape and gowns-Blue laminated non woven

BIOCOMPATIBILITY

















Biocompatibility studies has been done, and test results are given in the below table. Test results are within limits.

Table 31 Biocompatibility Study Documentation

Test Name	Test Method	Test facility	Report No	Report Date	Result
Cytotoxicity	ISO10993-5:2010	HACETTEPE UNIVERSITY	ARGEDS-2016/37	01.08.2016	Confirmed
Sensitization	ISO10993-10:2014	HACETTEPE UNIVERSITY	ARGEDS-2016/37	24.10.2016	Confirmed
Skin Irritation	ISO10993-10:2014	HACETTEPE UNIVERSITY	ARGEDS-2016/37	11.06.2016	Confirmed

Instruction for use:

1. The package of product shall be opened in sterile and aseptic conditions.
2. For a clean peel, open the package from the direction of the arrow slowly .
3. There are labels or marks on the drapes, which helps the user to follow the patient direction and unfolding directions.
4. For the is incision film or adhesive tape on the drapes,first of all peel the paper carrier and fix the drape on the operational area of the patient. After then unfold the drape by following the directions.
5. Surgical drapes are ready for the operation, when they are completely unfolded.

	Do not use if package is damaged		Manufacturer		Single Use (Do not re-use)		Use by date
	Do not expose the product to sunlight.		Catalogue number		Consult instructions for use		Temperature Limitation
	Do not re-sterilize		Manufacturing Date		Sterilized using Ethyleneoxide and Single sterile barrier system		CE Marking
	Keep Dry		Batch Code		Caution		Medical device
	Unique device identifier						